

Ficha Técnica

LINHA VERONA

METROPLANA

Código: 10.80.581

- Maçaneta em Zamac
- Roseta em Inox
- Máquina 4010/55 ou 6010/40
- Distância de Broca: 55mm ou 40mm



Aplicação

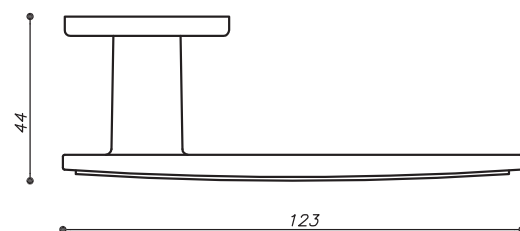

Acabamentos

-  **ZC** - Cromado
-  **ZCE** - Cromado Escovado
-  **ZBT** - Antique

Opcionais

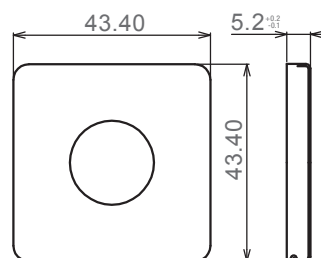

ROSETA QUADRADA PEQUENA
CÓD. 080

tradição & evolução

AROUCA
FECHADURAS



Produtos produzidos de
acordo com a NBR 14913



INOX 304
Premium
Super resistente à corrosão

Premium
Zamac
Qualidade 100% garantida

EMPRESA
100%
NACIONAL

Ficha Técnica

Máquinas de 55mm de broca

Faixa de espessura da porta: 30 a 40mm

Máquina externa: **4010/55**
1.296 variações de segredo

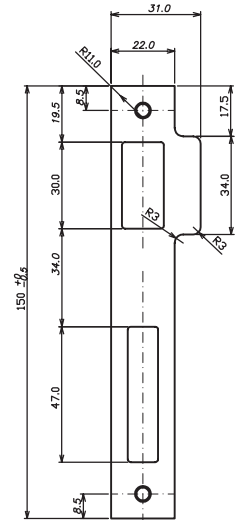
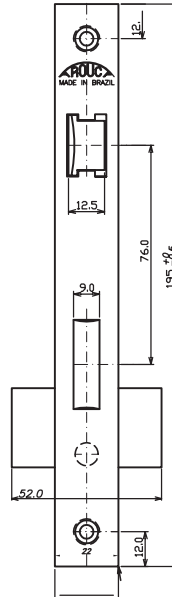
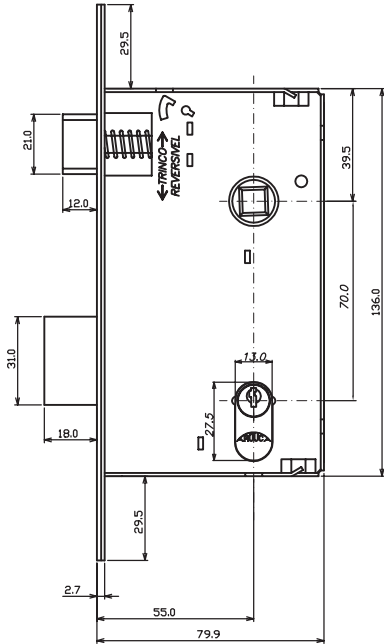

Máquina interna: **4040/55**
6 variações de segredo

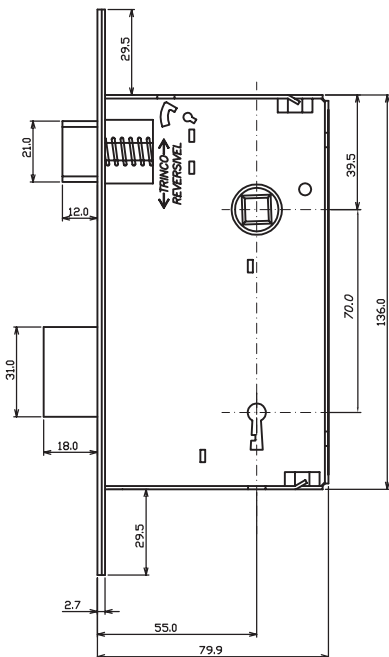

Máquina de banheiro: **4050/55**

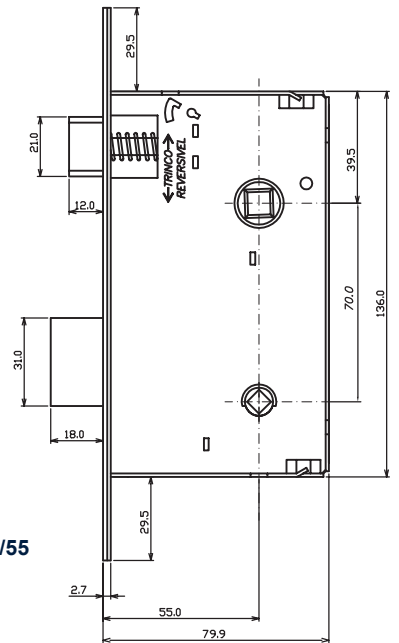

Frequência de uso:
tráfego intenso



Grau de resistência à
corrosão 2: ZCE/ZBT



Grau de resistência à
corrosão 3: ZC



Grau de segurança:
alta

tradição & evolução

AROUCA
FECHADURAS



Injeção de peças técnicas



ASSOCIAÇÃO
BRASILEIRA
DE NORMAS
TÉCNICAS

Produtos produzidos de
acordo com a NBR 14913



INOX 304
Premium
Super resistente à corrosão

Premium
Zamac
Qualidade 100% garantida

EMPRESA
100%
NACIONAL

Ficha Técnica

Máquinas de 40mm de broca

Faixa de espessura da porta: 30 a 40mm

Máquina externa: **6010/40**
1.296 variações de segredo

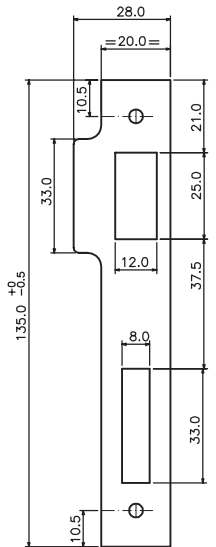
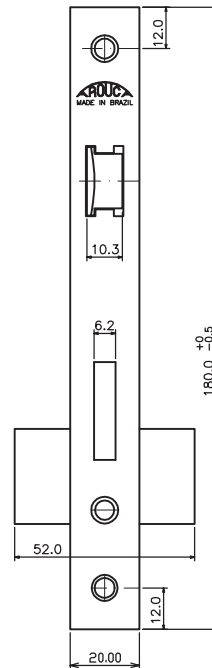
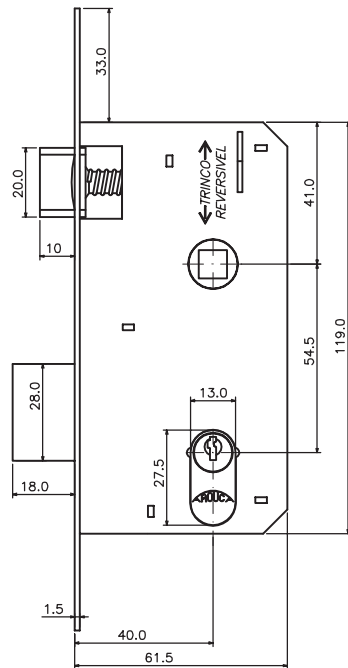

Máquina interna: **6040/40**
6 variações de segredo

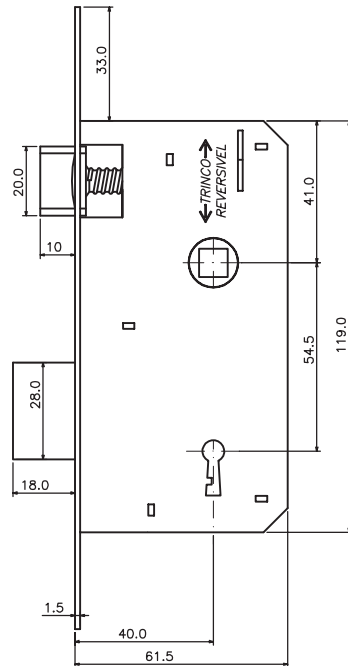

Máquina de banheiro: **6050/40**

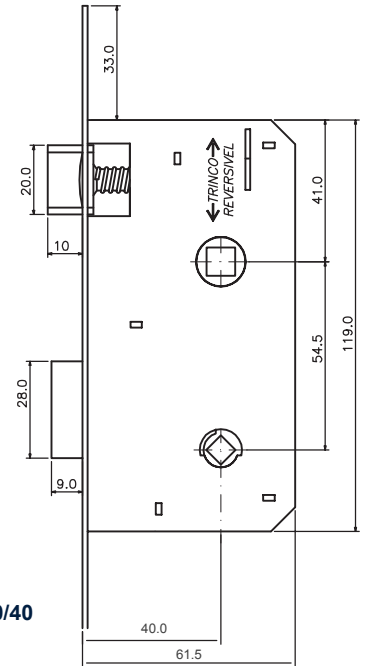

Frequência de uso:
trafego médio



Grau de resistência à
corrosão 2: ZCE/ZBT



Grau de resistência à
corrosão 3: ZC



Grau de segurança:
média

tradição & evolução

AROUCA
FECHADURAS



Injeção de peças técnicas



ASSOCIAÇÃO
BRASILEIRA
DE NORMAS
TÉCNICAS

Produtos produzidos de
acordo com a NBR 14913





INOX 304
Premium
Super resistente à corrosão





Premium
Zamac
Qualidade 100% garantida



EMPRESA
100%
NACIONAL

Ficha Técnica

Normas

FREQUÊNCIA DE USO	FUNCIONAMENTO DA LINGUETA PELA CHAVE (CICLOS)	FUNCIONAMENTO DO TRINCO PELA MAÇANETA (CICLOS)	FUNCIONAMENTO DO TRINCO POR ATAQUE LATERAL (CICLOS)	INTRODUÇÃO E RETIRADA DA CHAVE (CICLOS)	UTILIZAÇÃO DA FECHADURA
 Uso intenso	120.000	600.000	600.000	120.000	Residências, consultórios, escritórios, hospitais, shopping centers etc.
 Uso médio	75.000	300.000	300.000	75.000	Residências, consultórios, escritórios etc.
 Uso leve	35.000	100.000	100.000	35.000	Residências, comunicação entre cômodos etc.

GRAU DE RESISTÊNCIA	CONDIÇÕES DO AMBIENTE	TEMPO DE EXPOSIÇÃO EM SALT SPRAY
 Corrosão 4	Com condições severas quanto à umidade e intempéries (Ex.: regiões litorâneas)	144 horas
 Corrosão 3	Com umidade e intempéries (Ex.: áreas externas urbanas e rurais)	72 horas
 Corrosão 2	Com umidade e sem intempéries (Ex.: cozinhas e banheiros)	48 horas
 Corrosão 1	Sem umidade e sem intempéries (Ex.: salas e dormitórios)	24 horas

GRAU DE SEGURANÇA	UTILIZAÇÃO DA FECHADURA	RESISTÊNCIA
 Máxima	Portas externas, internas e banheiros	Fechadura de embutir cuja lingueta resista a um esforço lateral exercido pela contratesta de 10 kN
 Muito alta	Portas externas, internas e banheiros	Fechadura de embutir cuja lingueta resista a um esforço lateral exercido pela contratesta de 7 kN
 Alta	Portas externas, internas e banheiros	Fechadura de embutir cuja lingueta resista a um esforço lateral exercido pela contratesta de 5 kN
 Média 1	Portas externas, internas e banheiros	Fechadura de embutir cuja lingueta resista a um esforço lateral exercido pela contratesta de 3 kN
 Mínima	Portas internas e de banheiros	Fechadura de embutir cuja lingueta resista a um esforço lateral exercido pela contratesta de 2 kN

tradição & evolução

AROUCA
FECHADURAS



Injeção de peças técnicas



ASSOCIAÇÃO BRASILEIRA DE NORMAS TÉCNICAS

Produtos produzidos de acordo com a NBR 14913



INOX 304
Premium
Super resistente à corrosão

Premium
Zamac
Qualidade 100% garantida

EMPRESA
100%
NACIONAL